

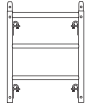

A-I SCAFFOLD MFG., INC.

590 Commerce Parkway | Hays, KS 67601
Ph 785.621.5121 | Fax 785.621.5122
www.a1scaffoldingmfg.com

WR Series Scaffold



WR-2931L



WR-2941L

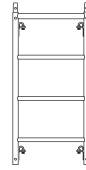

WR-2951L



WR-2967L

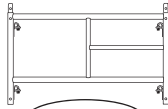

WR-531S

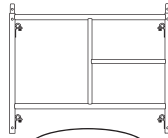

WR-541S

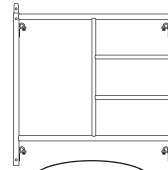

WR-551S

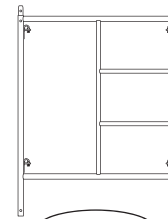

WR-567S

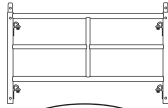

WR-531D

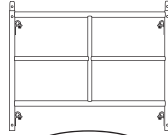

WR-541D

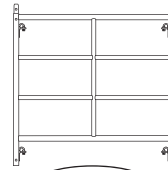

WR-551D

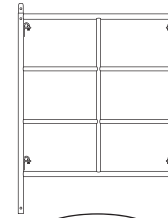

WR-567D

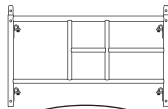

WR-531RT

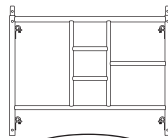

WR-541RT

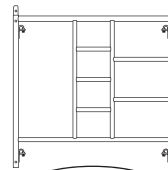

WR-551RT

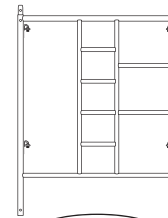

WR-567RT

Specifications

Part Number	Description	Weight (lbs.)
Ladder Frames		
WR-2931L	29" x 3'1" Ladder	21.0
WR-2941L	29" x 4'1" Ladder	24.0
WR-2951L	29" x 5'1" Ladder	29.0
WR-2967L	29" x 6'7" Ladder	37.0
WR-331L	3' x 3'1" Ladder	23.5
WR-341L	3' x 4'1" Ladder	30.0
WR-351L	3' x 5'1" Ladder	34.5
WR-367L	3' x 6'7" Ladder	40.5

Part Number	Description	Weight (lbs.)
Single Ladder Frames		
WR-521S	5' x 2'1" Single Ladder	25.3
WR-531S	5' x 3'1" Single Ladder	32.0
WR-541S	5' x 4'1" Single Ladder	35.0
WR-551S	5' x 5'1" Single Ladder	42.0
WR-567S	5' x 6'7" Single Ladder	48.2

Part Number	Description	Weight (lbs.)
Double Ladder Frames		
WR-531D	5' x 3'1" Double Ladder	34.0
WR-541D	5' x 4'1" Double Ladder	37.0
WR-551D	5' x 5'1" Double Ladder	46.0
WR-567D	5' x 6'7" Double Ladder	52.2

Part Number	Description	Weight (lbs.)
Rolling Tower Frames		
WR-531RT	5' x 3'1" Rolling Tower	40.2
WR-541RT	5' x 4'1" Rolling Tower	43.7
WR-551RT	5' x 5'1" Rolling Tower	52.5
WR-567RT	5' x 6'7" Rolling Tower	60.2

1 5/8" Dia. Tube
Holes at 90°
S Locks

Frames

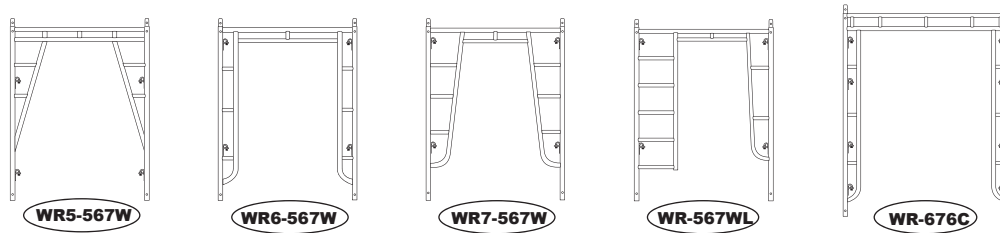

WR5-567W

WR6-567W

WR7-567W

WR-567WL

WR-676C

Specifications

Part Number	Description	Weight (lbs.)	Part Number	Description	Weight (lbs.)
Walk Thru Frames			Walk Thru Ladder		
WR-351W	3' x 5' 1" Walk Thru	34.0	WR-567WL	5' x 6' 7" Walk Thru Ldr	56.5
WR-367W	3' x 6' 7" Walk Thru	40.6	Canopy Frame		
WR-551W	5' x 5' 1" Walk Thru	42.0	WR-676C	6' x 7' 6" Canopy Frame	7.0
WR5-567W	5' x 6' 7" Walk Thru	49.0	1 5/8" Dia. Tube		
WR6-567W	5' x 6' 7" Walk Thru	56.5	Holes at 90°		
WR7-567W	5' x 6' 7" Walk Thru	51.6	S Locks		

Accessories

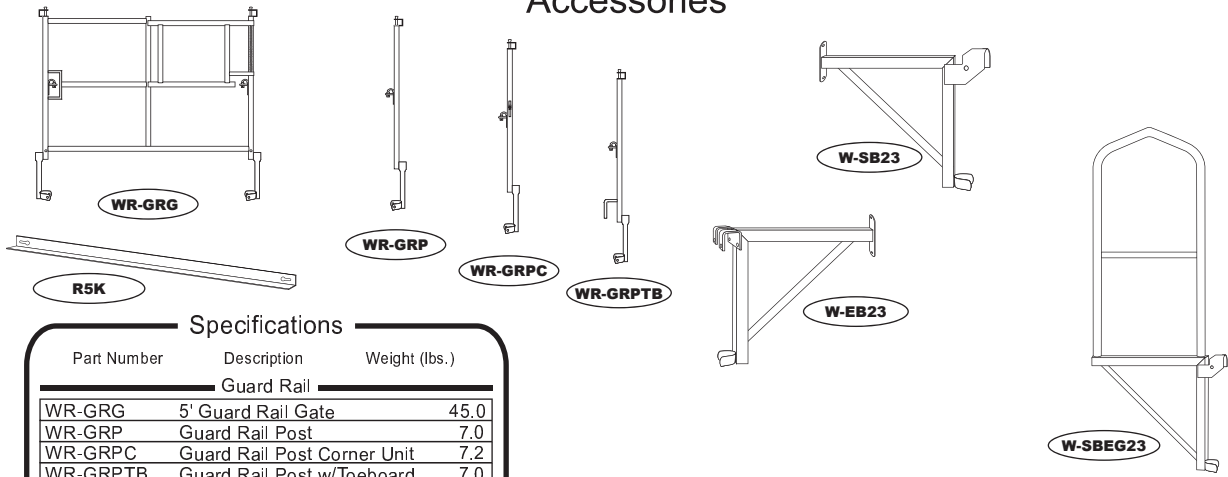

Specifications

Part Number	Description	Weight (lbs.)
Guard Rail		
WR-GRG	5' Guard Rail Gate	45.0
WR-GRP	Guard Rail Post	7.0
WR-GRPC	Guard Rail Post Corner Unit	7.2
WR-GRPTB	Guard Rail Post w/Toeboard	7.0
Key Hole Rails		
R29K	29" Key Hole Rail	2.5
R3K	3' Key Hole Rail	3.5
R4K	4' Key Hole Rail	4.0
R5K	5' Key Hole Rail	4.5
R6K	6' Key Hole Rail	5.0
R7K	7' Key Hole Rail	5.5
Side & End Brackets		
W-SB20	20" Side Bracket	9.0
W-SB23	23" Side Bracket	11.5
W-SB30	30" Side Bracket	13.0
W-EB20	20" End Bracket	9.0
W-EB23	23" End Bracket	11.5
W-SBEG20	20" Side Bracket End Guard	15.0
W-SBEG23	23" Side Bracket End Guard	16.0
Pins		
CPW	1 5/16" Coupling Pin w/o Collar	.5
CPW8	1 5/16" Coupling Pin w/ 1/8" Collar	.5
WR-SP	Saddle Pin	2.5
WR-SPL	Saddle Pin w/ Long Leg	3.0
SR	Spring Retainer	.03

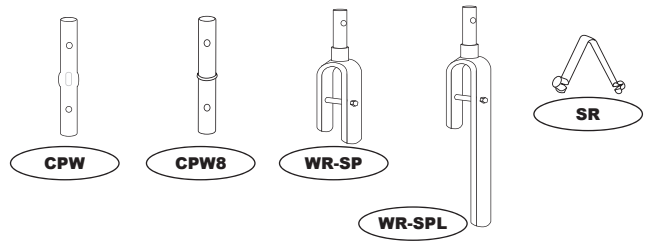

Frame Lock Styles

